

PICK YOUR PATH. BEAT THE GAME. BE THE HERO.

# ESCAPE

FROM A

# VIDEO GAME

MYSTERY ON THE STARSHIP CRUSADER



***Mystery on the Starship Crusader* worksheet.**

**Follow along!**

# CHOOSE GAME DIFFICULTY

EASY: INFINITE LIVES

MEDIUM: 

HARD: 

FROM PAGE 16

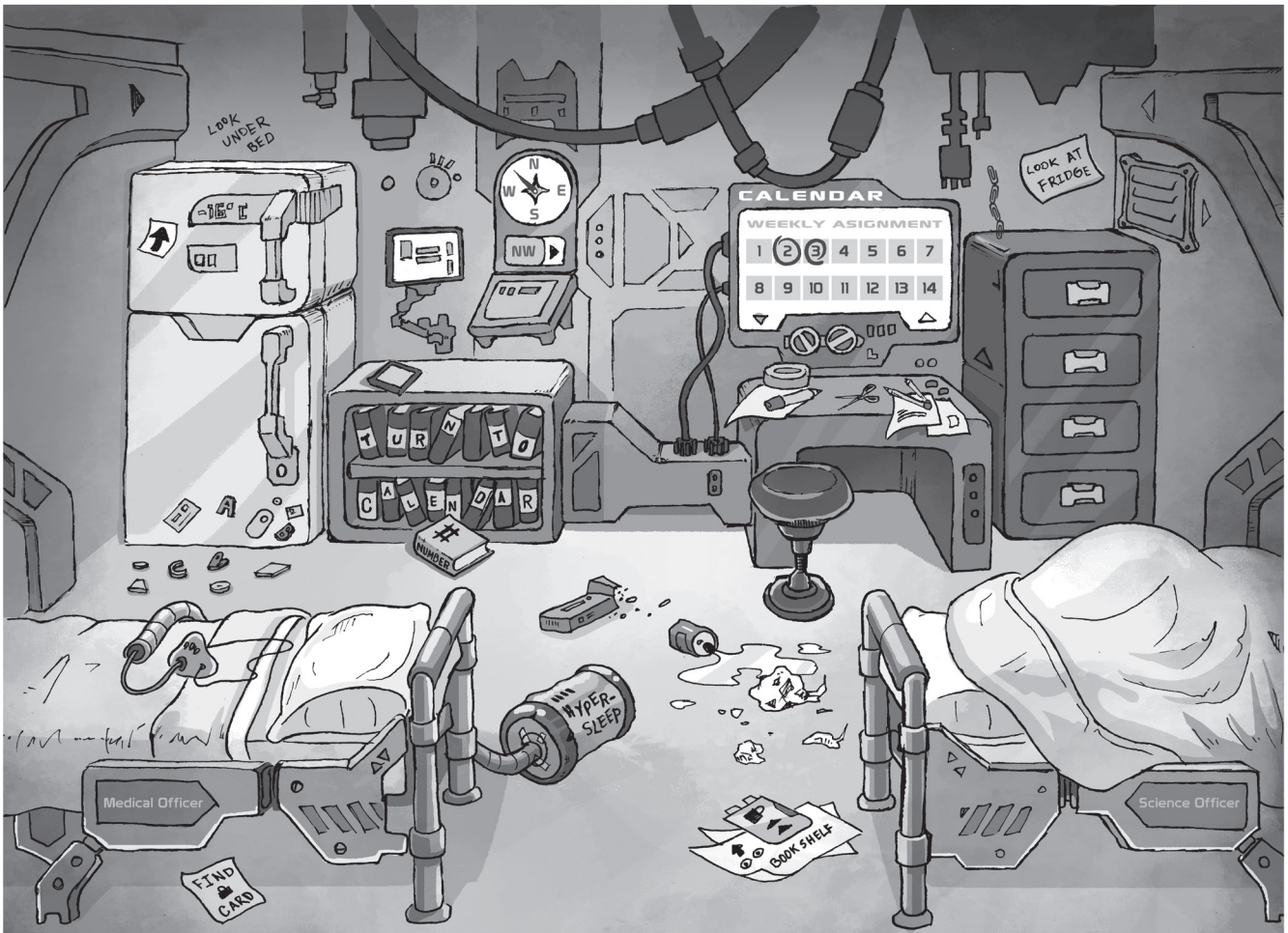

FROM PAGE 26



FROM PAGE 48

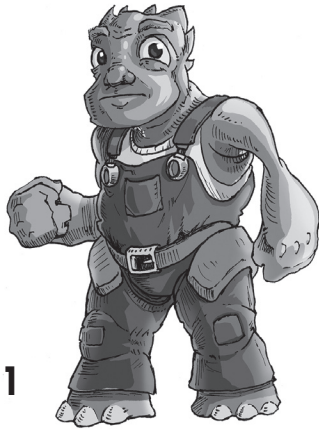

**TURN TO** 

P.

\_\_\_\_\_

\_\_\_\_\_

\_\_\_\_\_



GUN - #0



FIRE MODE:



GUN - #1



FIRE MODE:



GUN - #2



FIRE MODE:



GUN - #3

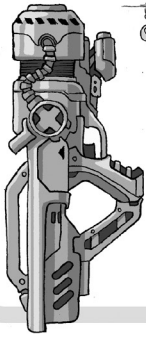

FIRE MODE:

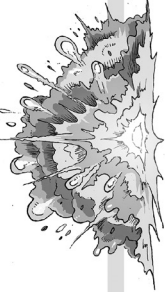

GUN - #4



FIRE MODE:

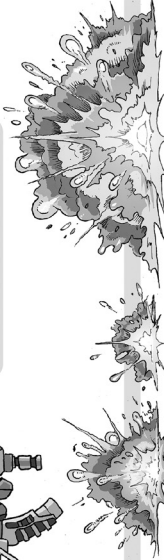

GUN - #5

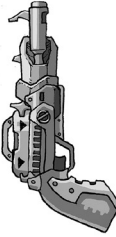

FIRE MODE:



TURN TO P.

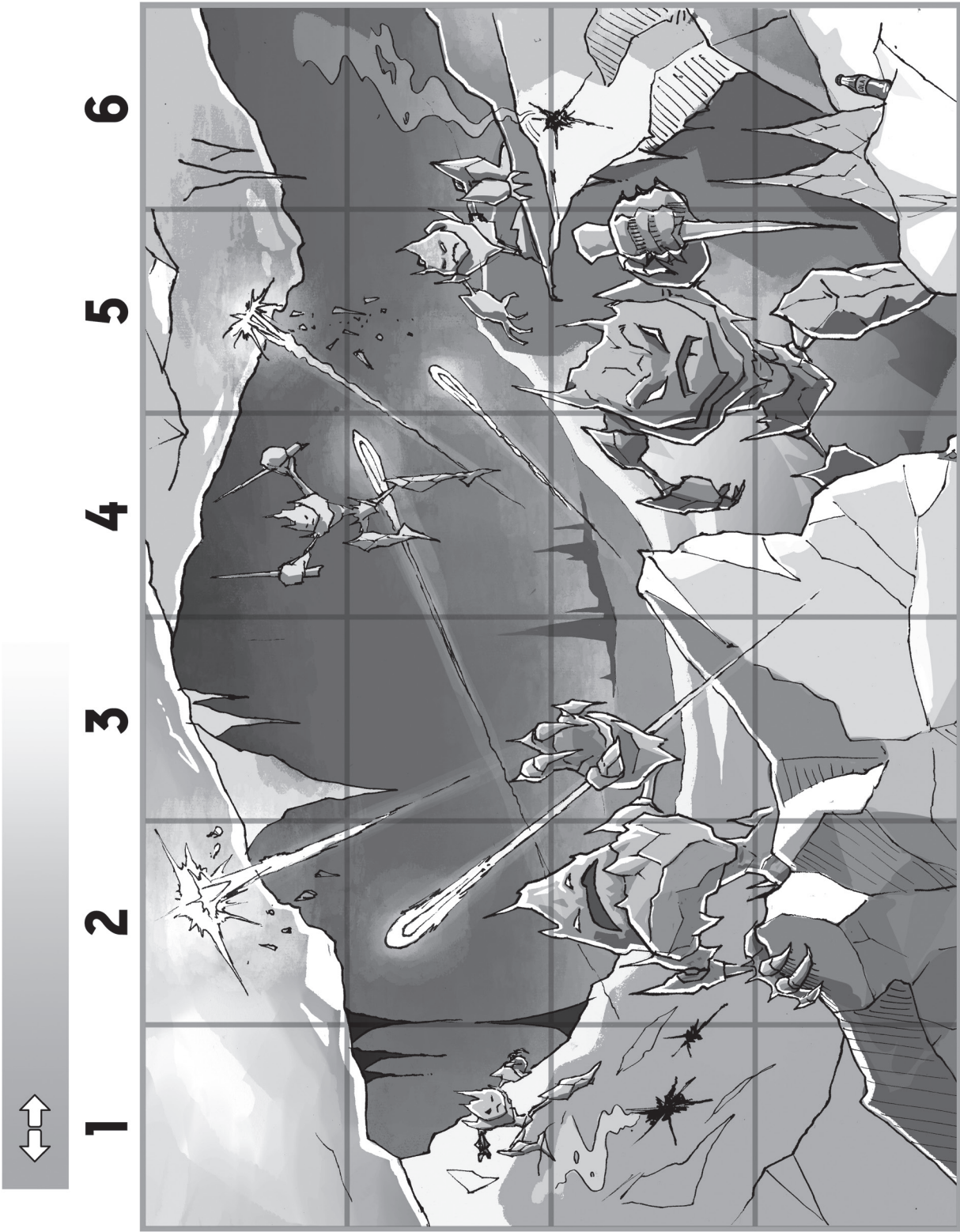

**TURN TO P.**



FROM PAGE 128

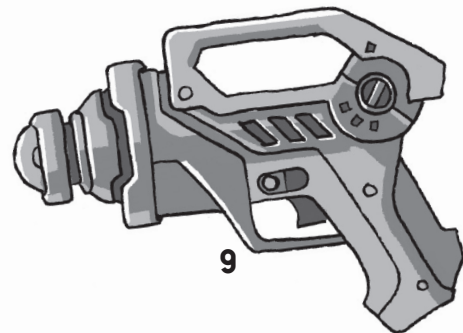
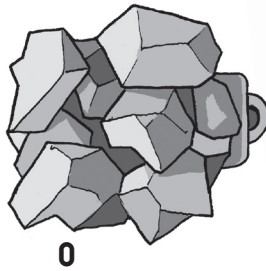
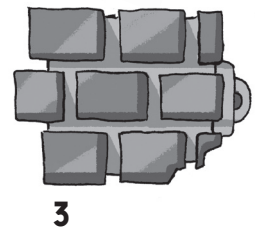
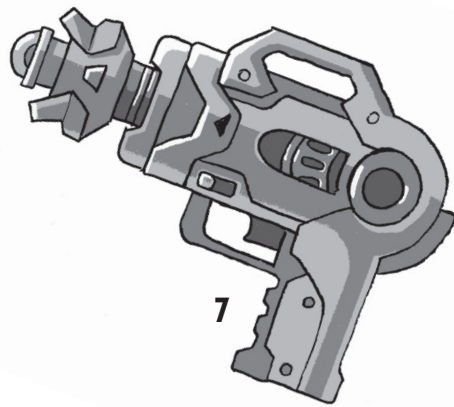
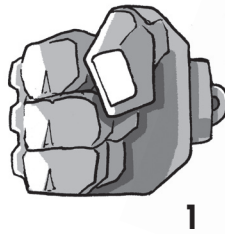
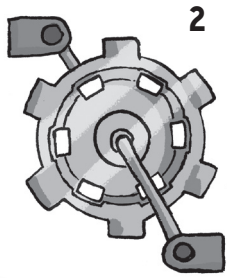

**TURN TO**

P.

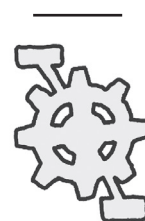
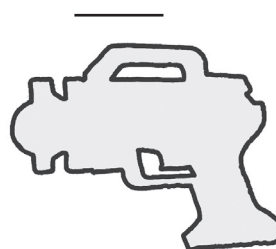
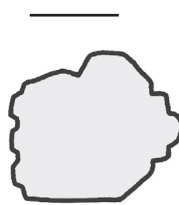

16	Pattern 16-1	Pattern 16-2	Pattern 16-3	Pattern 16-4	Pattern 16-5	Pattern 16-6	Pattern 16-7	Pattern 16-8	Pattern 16-9	Pattern 16-10
15	Pattern 15-1	Pattern 15-2	Pattern 15-3	Pattern 15-4	Pattern 15-5	Pattern 15-6	Pattern 15-7	Pattern 15-8	Pattern 15-9	Pattern 15-10
14	Pattern 14-1	Pattern 14-2	Pattern 14-3	Pattern 14-4	Pattern 14-5	Pattern 14-6	Pattern 14-7	Pattern 14-8	Pattern 14-9	Pattern 14-10
13	Pattern 13-1	Pattern 13-2	Pattern 13-3	Pattern 13-4	Pattern 13-5	Pattern 13-6	Pattern 13-7	Pattern 13-8	Pattern 13-9	Pattern 13-10
12	Pattern 12-1	Pattern 12-2	Pattern 12-3	Pattern 12-4	Pattern 12-5	Pattern 12-6	Pattern 12-7	Pattern 12-8	Pattern 12-9	Pattern 12-10
11	Pattern 11-1	Pattern 11-2	Pattern 11-3	Pattern 11-4	Pattern 11-5	Pattern 11-6	Pattern 11-7	Pattern 11-8	Pattern 11-9	Pattern 11-10
10	Pattern 10-1	Pattern 10-2	Pattern 10-3	Pattern 10-4	Pattern 10-5	Pattern 10-6	Pattern 10-7	Pattern 10-8	Pattern 10-9	Pattern 10-10
9	Pattern 9-1	Pattern 9-2	Pattern 9-3	Pattern 9-4	Pattern 9-5	Pattern 9-6	Pattern 9-7	Pattern 9-8	Pattern 9-9	Pattern 9-10
8	Pattern 8-1	Pattern 8-2	Pattern 8-3	Pattern 8-4	Pattern 8-5	Pattern 8-6	Pattern 8-7	Pattern 8-8	Pattern 8-9	Pattern 8-10
7	Pattern 7-1	Pattern 7-2	Pattern 7-3	Pattern 7-4	Pattern 7-5	Pattern 7-6	Pattern 7-7	Pattern 7-8	Pattern 7-9	Pattern 7-10
6	Pattern 6-1	Pattern 6-2	Pattern 6-3	Pattern 6-4	Pattern 6-5	Pattern 6-6	Pattern 6-7	Pattern 6-8	Pattern 6-9	Pattern 6-10
5	Pattern 5-1	Pattern 5-2	Pattern 5-3	Pattern 5-4	Pattern 5-5	Pattern 5-6	Pattern 5-7	Pattern 5-8	Pattern 5-9	Pattern 5-10
4	Pattern 4-1	Pattern 4-2	Pattern 4-3	Pattern 4-4	Pattern 4-5	Pattern 4-6	Pattern 4-7	Pattern 4-8	Pattern 4-9	Pattern 4-10
3	Pattern 3-1	Pattern 3-2	Pattern 3-3	Pattern 3-4	Pattern 3-5	Pattern 3-6	Pattern 3-7	Pattern 3-8	Pattern 3-9	Pattern 3-10
2	Pattern 2-1	Pattern 2-2	Pattern 2-3	Pattern 2-4	Pattern 2-5	Pattern 2-6	Pattern 2-7	Pattern 2-8	Pattern 2-9	Pattern 2-10
1	Pattern 1-1	Pattern 1-2	Pattern 1-3	Pattern 1-4	Pattern 1-5	Pattern 1-6	Pattern 1-7	Pattern 1-8	Pattern 1-9	Pattern 1-10
1	1	2	3	4	5	6	7	8	9	10

**TURN TO** P.





# Secret Message

Fill in the secret letter that goes with each achievement. When you enter all the letters, you'll spell a phrase. Enter that phrase at [escapefromavideogame.com](http://escapefromavideogame.com) to unlock a secret story.

\_\_\_ ROBOT PRETZEL

\_\_\_ UNNECESSARY WATERFALL

\_\_\_ NO EVIDENCE IS THE WORST EVIDENCE

\_\_\_ GOOP, GLOP, GULP

\_\_\_ SOMETHING A PIRATE WOULD SAY

\_\_\_ READY TO RUMBLE

\_\_\_ I'M THE DOCTOR NOW

\_\_\_ STUDENT DRIVER

\_\_\_ THE GHOST

\_\_\_ WHO'S YOUR DADDY?

\_\_\_ AAHOOGA

\_\_\_ POOPY HAIR

\_\_\_ DUMB GUARD

\_\_\_ VICTORY

\_\_\_ STUN/KILL

\_\_\_ PLANET GROOB

\_\_\_ NO OFFENSE

\_\_\_ CLUE-ISH

\_\_\_ PALITA LOVES VIDEO GAMES

\_\_\_ CLOMP

\_\_\_ IT'S NOT POLITE TO POINT

\_\_\_ SMART FOR A WOODCHUCK

\_\_\_ NOTHING MAKES SENSE

\_\_\_ HEAVY STUFF

\_\_\_ MACGYVER HACKING

\_\_\_ FINISHED

\_\_\_ SABOTAGE

\_\_\_ YOU'RE SQUISHY

\_\_\_ THE ASTEROID ALWAYS WINS

\_\_\_ HALLOWEEN COSTUME

\_\_\_ HYPERACTIVE SLEEP

\_\_\_ UNFIXABLE

\_\_\_ NOT A DENTIST

\_\_\_ PERRY MASON

\_\_\_ DUMB TOUPEE LIZARD

\_\_\_ FIRST INTERROGATION

\_\_\_ SO SUCKY

\_\_\_ TERRIBLE AT BASEBALL

\_\_\_ NEW TAIL SCHOOL

\_\_\_ SLUG-O-MATIC

\_\_\_ BLUE SCREEN OF DEATH

\_\_\_ SPIDER GUY

\_\_\_ RUSTY SCUBA GARBAGE

\_\_\_ IT WAS ALL A DREAM

\_\_\_ TOO CHEESY

\_\_\_ DYING CLUE